

A Revolutionary New Filtration Technology

WasteWizard®

- Patented ultrafilter membrane technology
- Drastically lowers disposal cost--Reduces oily waste generated by up to 99%
- Low cost, easy installation--Plug in and run design
- Simple to use, self contained design



RANSOHOFF
Providing Tomorrow's Cleaning Technology Today

WasteWizard®

Ransohoff's WasteWizard System is a revolutionary new filtration technology for recycling of aqueous cleaner baths. Designed as a low maintenance ultrafiltration process to filter out and collect emulsified soils and fin particulate that reduces the useful life of your cleaning solutions.

Ransohoff's WasteWizard System is a compact, fully integrated system for point-of-use recycling. The system comes complete with its own fluid transfer system that automatically exchanges the dirty cleaner from the washer with recycled cleaner. The WasteWizard sits on an integral concentration tank for convenient waste collection and disposal once the oil and solids have been concentrated to a high level.

The WasteWizard System, when used in conjunction with the Evercycle™ line of recyclable chemistries has the ability to fully recycle the cleaning chemistry saving thousands of dollars in chemical usage, labor, waste processing and hauling. In addition, the WasteWizard System will improve cleaning quality and consistency that typically go off-spec as oil and contaminants build up in the solution tank.

Benefits

- With the Use of Ransohoff's Evercycle Chemistries, this Unit will Allow 100% Pass Through of the Chemistry
- Minimal Operator Attention
- Smart Diagnostics Self Control the Unit Under Varying Conditions
- No Pre-filtration; Made to Handle High Solids
- Automatic Cleaning Cycles Via Programmed Permeate Shut Off
- Patented Ultrafilic Membrane Assures Highest Output
- The Unique Properties of the Evercycle Line of Cleaners Provide a Protective Coating to the Membrane Surface Further Enhancing it's Anti-fouling Characteristics.

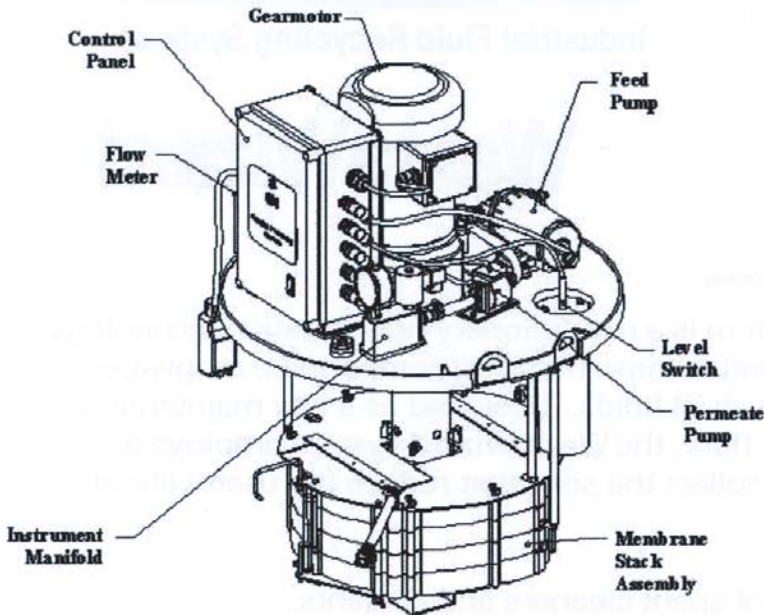

Model #	GPD Permeate At 77 °F
EC-1	100
EC-2	200
EC-3	300
EC-4	400
EC-5	500

Maximum Temperature is 170 °F (76 °C)
pH Range is 2-11



Ransohoff Specialty Chemicals Group Blackstone~NEY Ultrasonics Ransohoff Environmental Systems Group CTG MEDICAL



ISO 9001:2008
FM 44733



ISO 14001:2004
EN6 40526

4933 Provident Drive • Cincinnati, Ohio 45246
Tel: (513) 870-0100 • Fax: (513) 870-0105
EMAIL: info@ransohoff.com • www.ransohoff.com